

The SEQR Cookbook

A Step-by-Step Discussion of the Basic SEQR Process



State Environmental Quality Review Act
New York State Department of Environmental Conservation

Division of Environmental Permits

George E. Pataki, *Governor*

Erin M. Crotty, *Commissioner*

Revised 2004



The SEQR Cookbook

A Step-by-Step Discussion of the Basic SEQR Process



The Department of Environmental Conservation received rave reviews on the *SEQR Cookbook*. This version reflects changes to the statewide SEQR Regulations, 6 NYCRR Part 617, effective in January 1996 and DEC address changes that have occurred since the last printing. The Cookbook takes the reader through the SEQR process step-by-step. However, the Cookbook is not intended to serve as the sole source of information about SEQR. For this reason, each step of the Cookbook refers to the appropriate section of Part 617. Definitions of terms can be found in 6 NYCRR Section 617.2.

Information about SEQR, including an on-line version of this Cookbook, can also be found on the DEC website: <http://www.dec.state.ny.us/website/dcs/seqr>

The following Department staff contributed their efforts to the production of this edition of the revised SEQR Cookbook:

Jack Nasca, Betty Ann Hughes, and Andrea Bergstrom, Division of Environmental Permits
Bob deVilleneuve and Helen Paruolo, Division of Public Affairs
Jeffrey Sama prepared the "SEQR Chef" illustrations found throughout the Cookbook.

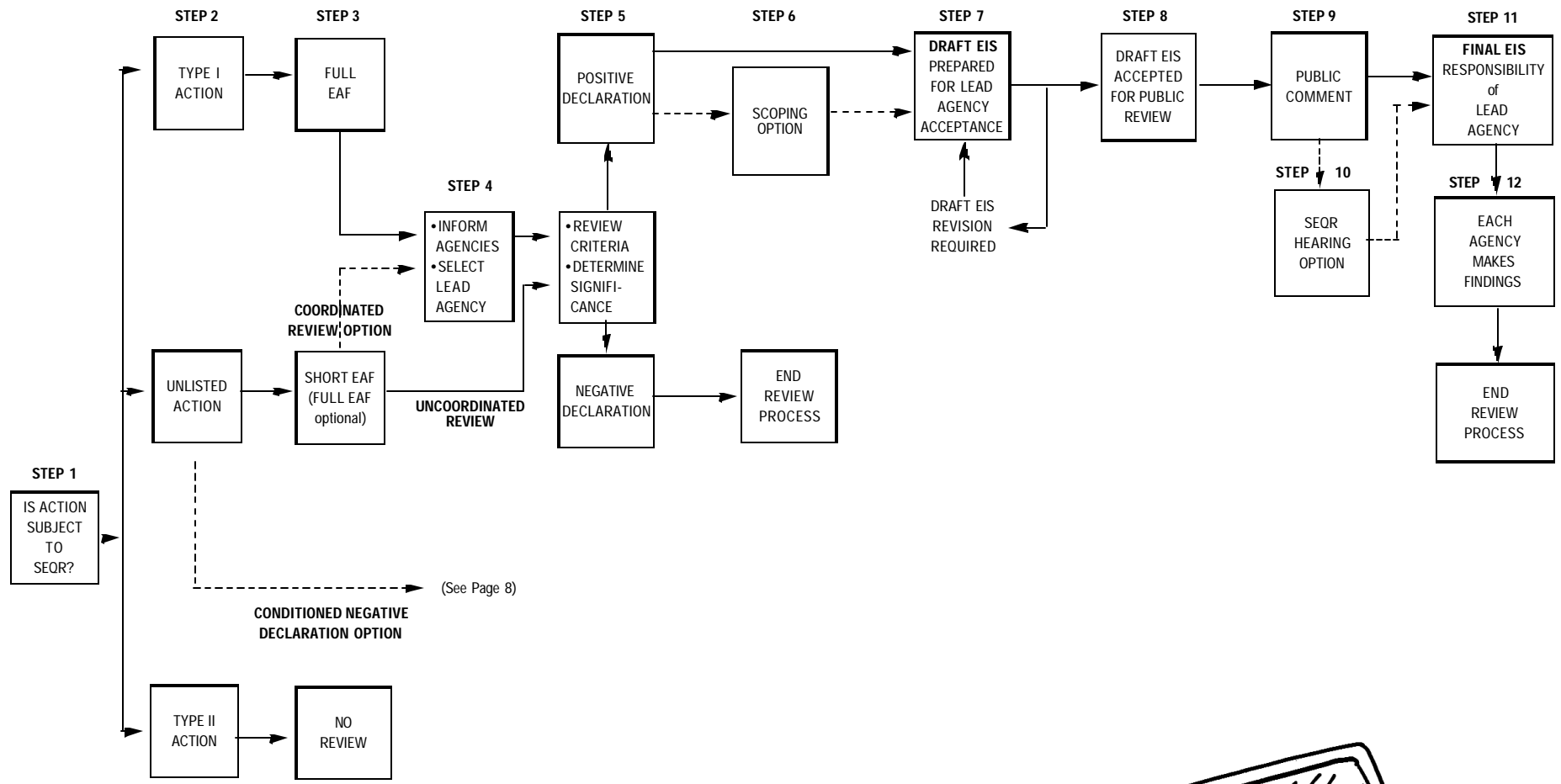

The SEQR Process

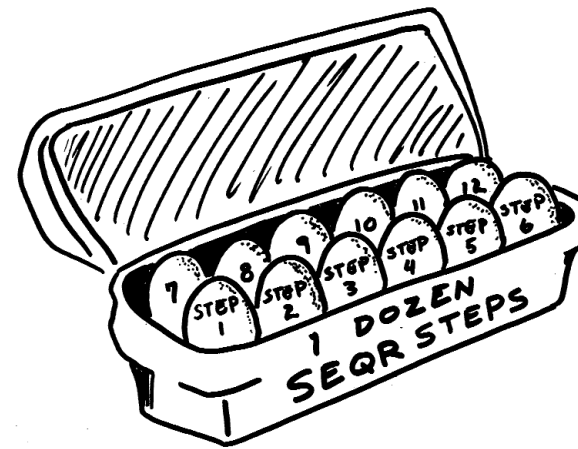

STEP 1

IS ACTION
SUBJECT
TO
SEQR?



Step 1. Is the Action Subject to SEQR?

An action is subject to review under SEQR if any state or local agency has the authority to issue a discretionary permit, license or other type of approval for that action. SEQR also applies if an agency funds or directly undertakes a project, or adopts a resource management plan, rule or policy that affects the environment. If the proposed action does not require a discretionary decision, there is no requirement for review under SEQR. If the proposed action requires a discretionary approval, proceed to Step 2.

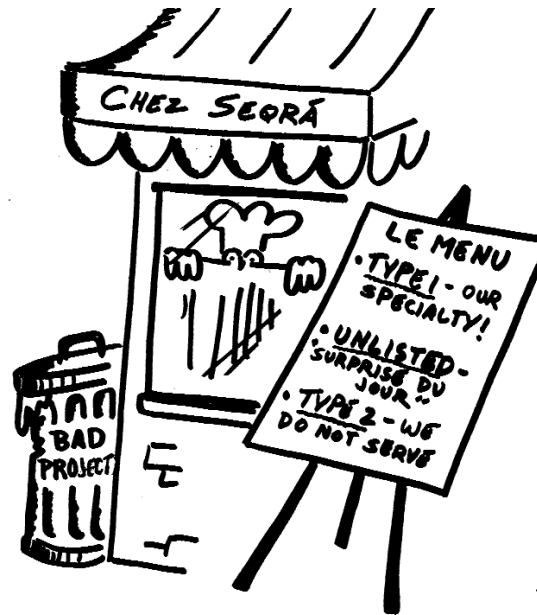
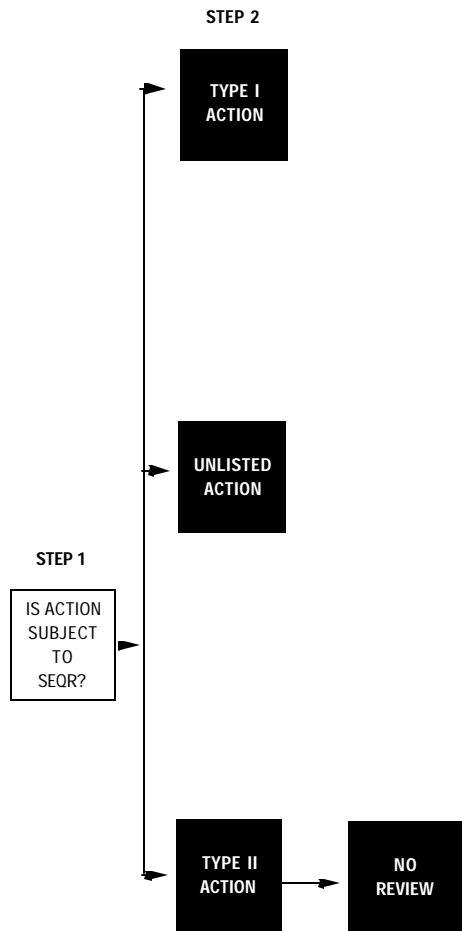

Step 2. Classify the Action

The next step in the SEQR process is to classify the action.

a. Actions Requiring No Further Review Under SEQR

- Type II—An action contained on the list in section 617.5 or on an agency’s locally adopted Type II list. Type II actions have been determined not to have a significant impact or are otherwise precluded from environmental review under SEQR. Type II actions never require the preparation of a determination of significance or a draft environmental impact statement (EIS).

If an action is classified as Type II, review under SEQR is completed. Although not required, an agency may choose to provide documentation in the project file that the action has been classified as Type II.

b. Actions Which Require Further Review Under SEQR

- Type I—An action that meets or exceeds a threshold contained on the list in section 617.4 or one that is on an agency’s locally adopted Type I list. Type I actions are more likely to have a significant adverse impact on the environment than Unlisted actions and may require the preparation of a draft EIS.
- Unlisted—An action that does not meet or exceed the thresholds contained on the Type I list and is not contained on the Type II list. An Unlisted action requires a determination of significance and may require the preparation of a draft EIS.

If the action is classified as a Type I action, proceed to Step 3a. If the action is classified as an Unlisted action, proceed to Step 3b.

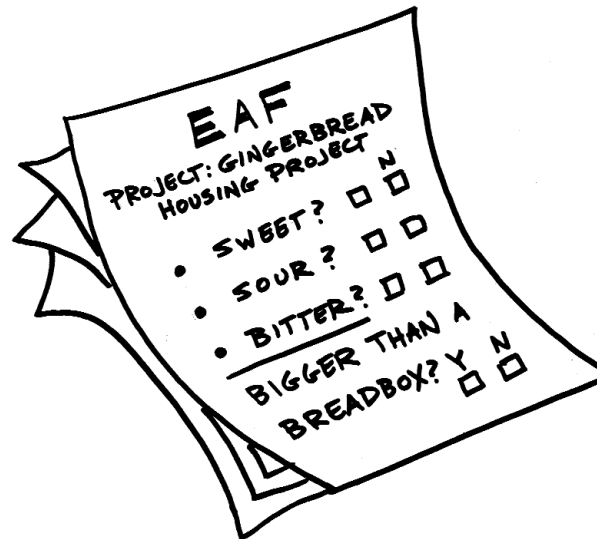
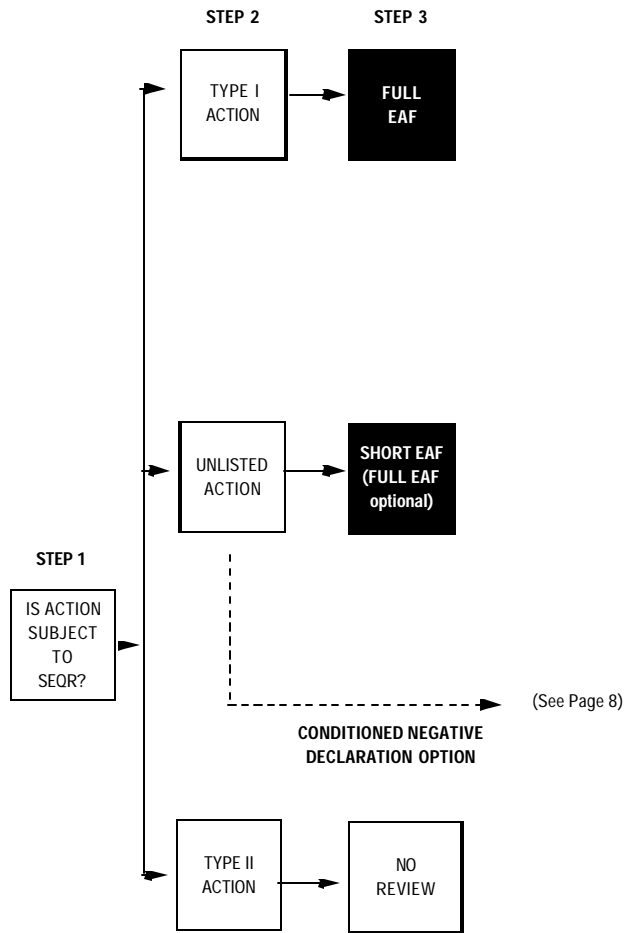

Step 3. Complete Environmental Assessment Forms (EAF)

a. Type I Actions

A full Environmental Assessment Form (full EAF) must be prepared for all Type I actions (617.20 Appendix A). The project sponsor/applicant completes Part I of the form and submits it to an involved agency together with any other applications that are required. When the lead agency is established (see step 4), that agency is responsible for completing Part 2 of the EAF and, as needed, Part 3. The requirement for a full EAF may be waived if a draft EIS is prepared and submitted with the application. Proceed to Step 4a.

b. Unlisted Actions

A short Environmental Assessment Form (short EAF) must, at a minimum, be completed for all Unlisted actions (617.20 Appendix C). The project sponsor/applicant completes Part 1 of the form and submits it to an involved agency together with any other applications that are required. When the lead agency is established (see Step 4), that agency is responsible for completing Part 2 and, as needed, Part 3. An agency may require a full EAF if the short EAF will not provide sufficient information, or it may waive the requirement for an EAF if a draft EIS is prepared and submitted with the application.

Unlisted actions range from very minor activities to actions falling just below Type I thresholds. Coordinated review is not required for Unlisted actions. Proceed to step 4b.

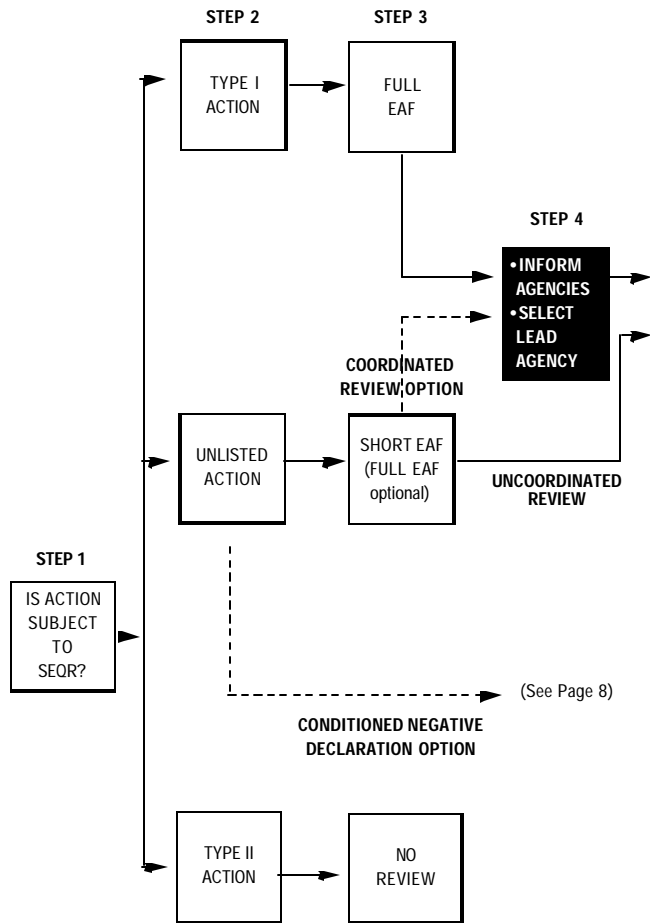

Step 4. Coordinate Review

a. Type I Actions

Coordinated review is required for all Type I actions. The involved agency that initially receives an application for approval circulates to the other involved agencies the completed Part 1 of the full EAF and any other information supplied by the applicant. The involved agencies should be identified by the applicant in the full EAF (Part 1,B, questions 24 & 25).

If there is only one agency approving, funding or directly undertaking an action, that agency is automatically the lead agency. If there are two or more involved agencies, a lead agency must be established by agreement of the agencies within 30 calendar days. If any involved agency desires to be lead agency, it can indicate in the coordination request its willingness to act as lead agency and state that, if no response is received within 30 calendar days, it will assume the role of lead agency. If the lead agency cannot be agreed on within 30 calendar days, any of the involved agencies or the applicant can ask the Commissioner of the Department of Environmental Conservation to resolve the dispute and designate the lead agency [see 617.6(b)(5)]. When the lead agency has been established/designated, proceed to Step 5.

b. Unlisted Actions

- *Coordinated Review Option*

If any involved agency decides to coordinate the review, or intends to require a draft EIS, that agency must contact the other involved agencies informing them of the decision to coordinate. The involved agencies should be identified by the applicant in either the short EAF, (Part 1, question 10) or the full EAF (Part 1,B, questions 24 & 25).

Coordination then occurs using the procedures for coordinating a Type I action (return to Step 4a). The only difference in coordinating review for an Unlisted action is that either a short EAF or a full EAF may be used.

For Unlisted actions only, there is an option to not coordinate review.

- *Uncoordinated Review Option*

Each involved agency acts as a lead agency and independently conducts an environmental review and determines the significance of the action (go to Step 5). If all involved agencies issue negative declarations, the project may go forward. If any of the involved agencies issues a positive declaration, requiring an EIS, all the other determinations of non-significance are superseded and a coordinated review must commence.

- *Conditioned Negative Declaration Option*

If, during the review of an application and the EAF submitted by an applicant on an Unlisted action, an involved agency determines that the potentially significant impact(s) could be eliminated or reduced to a non-significant level through imposed conditions, the agency may consider using the Conditioned Negative Declaration (CND) process. The use of the CND process requires a full EAF and coordinated review. For a brief discussion of the CND process, see Step 5b.

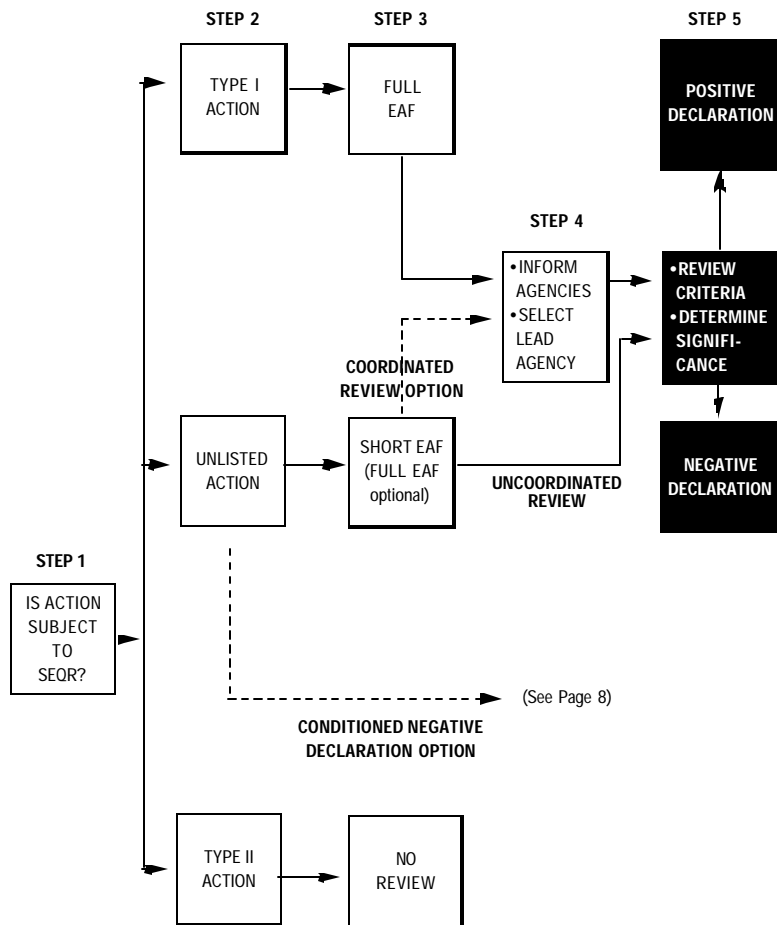

Step 5. Determine Significance

The lead agency has 20 calendar days to make its determination of significance. If the lead agency finds that it does not have sufficient information to make this determination, it may request that the applicant provide it. The lead agency must make its determination within 20 days of receipt of all the information it reasonably needs. In determining significance, the lead agency must consider:

- the whole action and the criteria [see 617.7(c)];
- the EAF and any other information provided by the applicant;
- involved agency input, where applicable; and
- public input, if any.

If the lead agency has determined that the proposed action will not have a significant adverse impact on the environment (Negative Declaration), proceed to Step 5a. If the proposed action is an Unlisted action involving an applicant and it will not have a significant adverse impact on the environment due to imposed conditions, proceed to Step 5b. If the proposed action may have a significant adverse impact on the environment (Positive Declaration), proceed to Step 5c.

a. Type I Action and Unlisted Action Negative Declarations

Every negative declaration must:

- identify the relevant areas of environmental concern;
- thoroughly analyze the relevant concerns; and
- document the determination, in writing, showing the reasons why the environmental concerns that were identified and analyzed will not be significant.

Unsupported statements such as “the action will not have a significant impact” or “no significant impacts were identified in the EAF” are assertions that are not legally sufficient for a negative declaration. Such statements must be supported with adequate detail to explain why there will be no significant impacts. For a Type I action, the agency must, in addition to maintaining a file that is readily accessible to the public, prepare, file, publish and distribute the Negative Declaration as described in section 617.12. For an Unlisted action, the reviewing agency must maintain a file readily accessible to the public containing the Negative Declaration.



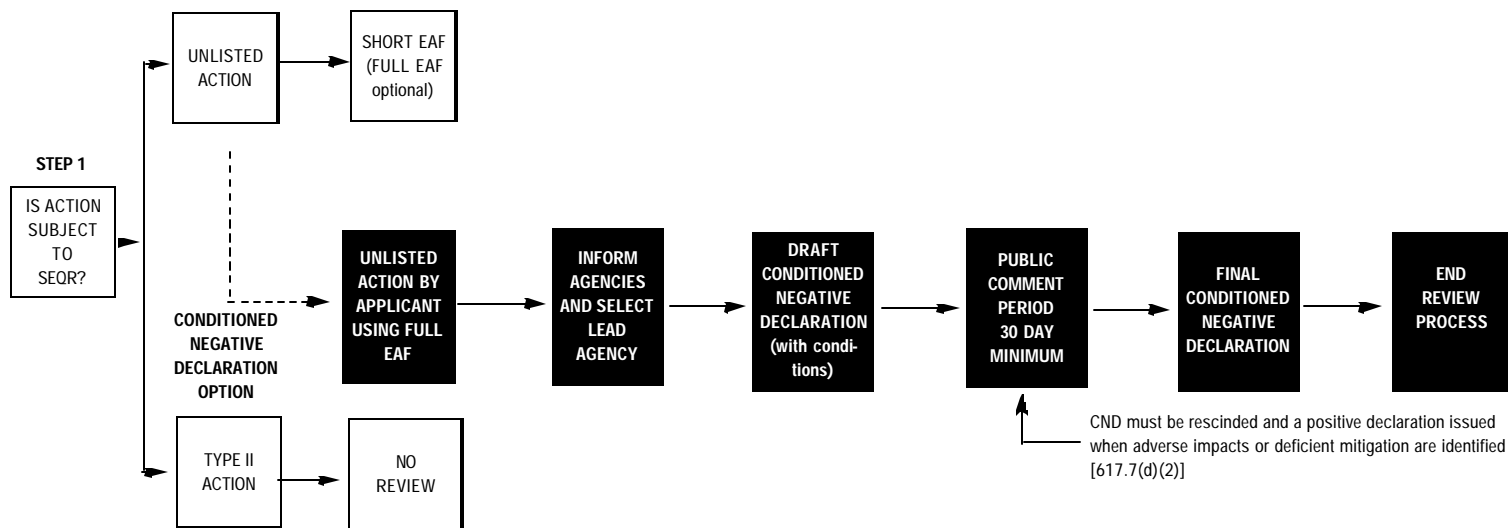

b. Conditioned Negative Declarations (CND)

For Unlisted actions that involve an applicant, the lead agency can choose to use the CND procedure. The following elements are necessary to support the use of a CND:

- a full EAF has been prepared;
- a coordinated review has been completed [see 617.6(b)(3)];
- the SEQR conditions imposed [see 617.3(b) and 617.7(d)(1)(iii)] have eliminated or reduced the identified potentially significant adverse impact(s) to a non-significant level;
- the notice is filed and published the same as for Type I actions [see 617.12(b) and (c)];
- a 30 day minimum public comment period has been provided (commencing with the appearance of the notice in the “Environmental Notice Bulletin”) stating what conditions have been imposed.

The conditions appropriate for use in a CND are those outside the normal jurisdiction of the agency. A condition that requires analysis of the results of a future study is inappropriate. This information must be available prior to determining significance. If comments are received that, in the lead agency’s judgment, would support the preparation of a draft EIS, or if the applicant requests an EIS, proceed to Step 6.

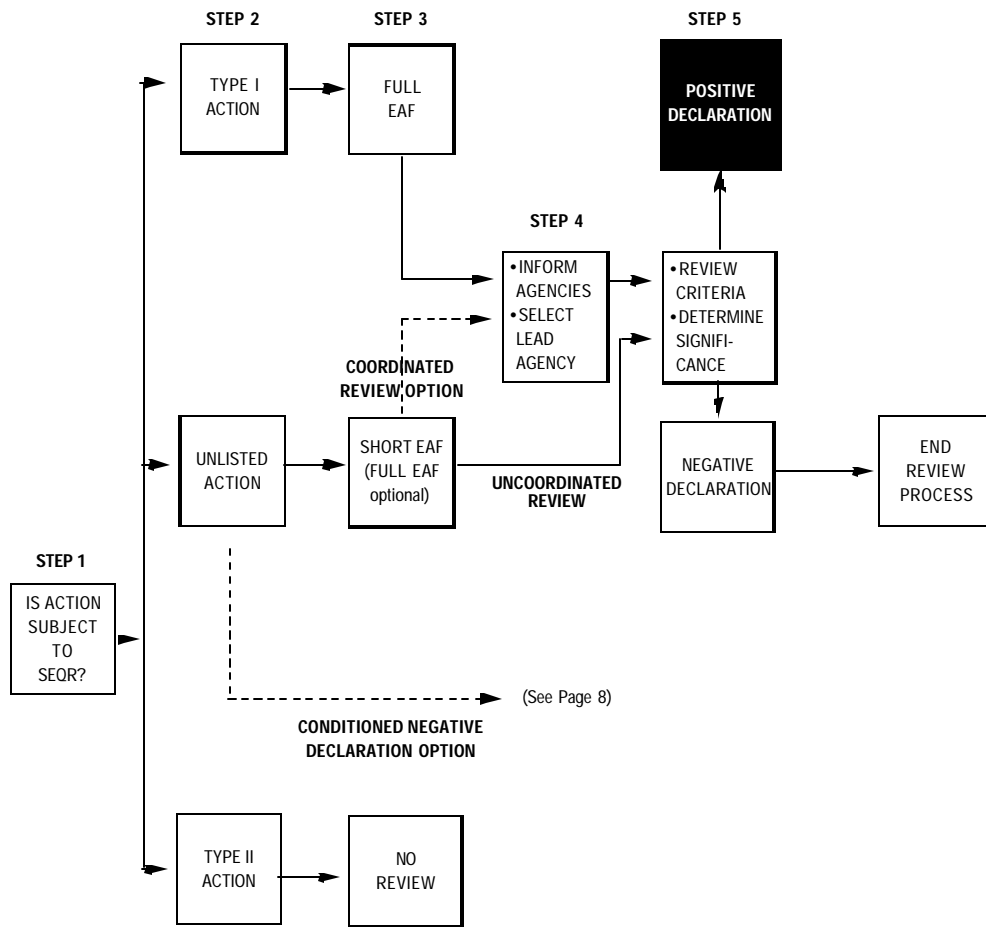

c. Positive Declarations

If the lead agency has determined that the proposed action may result in a significant adverse impact and, therefore, will require the preparation of an environmental impact statement, it must prepare and file a notice of that determination known as a Positive Declaration. The Positive Declaration must be prepared, filed, distributed and published as prescribed in section 617.12 and it must state whether scoping will be conducted. Proceed to Step 6.

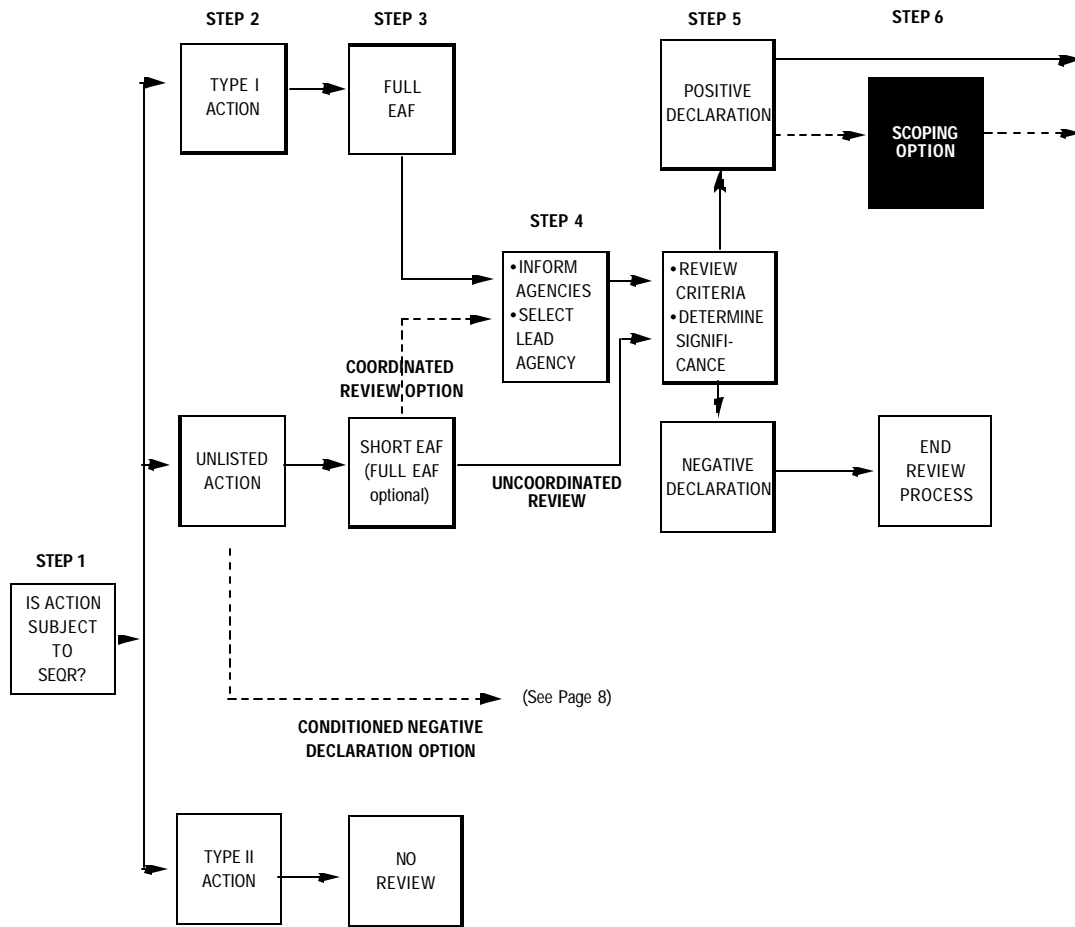

Scoping may be initiated either by the lead agency or at the request of the applicant. The project sponsor must provide the lead agency with a draft scope that contains the items identified in paragraphs 617.8(f)(1) through (5).

The lead agency must provide a copy of the draft scope to all involved agencies and make it available to anyone who has written to express an interest in the project. If the action involves an applicant, within 60 days of the receipt of the draft scope, the lead agency must supply a final written scope of issues to be addressed in the draft EIS to the applicant, all involved agencies and any individual who has expressed an interest in writing. If the lead agency fails to provide a final written scope to the applicant within 60 days, the applicant may prepare and submit a draft EIS consistent with the submitted draft scope.

Involved agencies should participate in the scoping process, alerting the lead agency of their agency’s concerns, jurisdiction(s) and information they will need to make their SEQR findings. The lead agency must provide a reasonable opportunity for the public and other interested agencies to participate in the scoping process. The DEC suggests that a minimum 20-day period for public review of the draft scope would be reasonable under most circumstances. Public participation can be accomplished by meetings, exchanges of written material or other methods. Proceed to Step 7.

Step 6. Scope Draft Environmental Impact Statement (Draft EIS)

Scoping is the process by which the issues to be addressed in the draft EIS are identified. While scoping is not required by Part 617, it is highly recommended for all draft EIS’s.

The scoping process has six objectives:

- focus the draft EIS on the potentially significant adverse environmental impacts;
- eliminate non-significant and non-relevant issues;
- identify the extent and quality of information needed;
- identify the range of reasonable alternatives to be discussed;
- provide an initial identification of mitigation measures; and
- provide the public with an opportunity to participate in the identification of impacts.

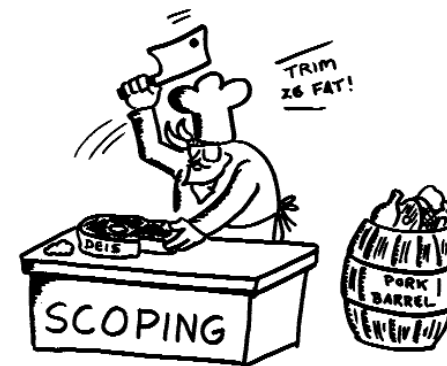

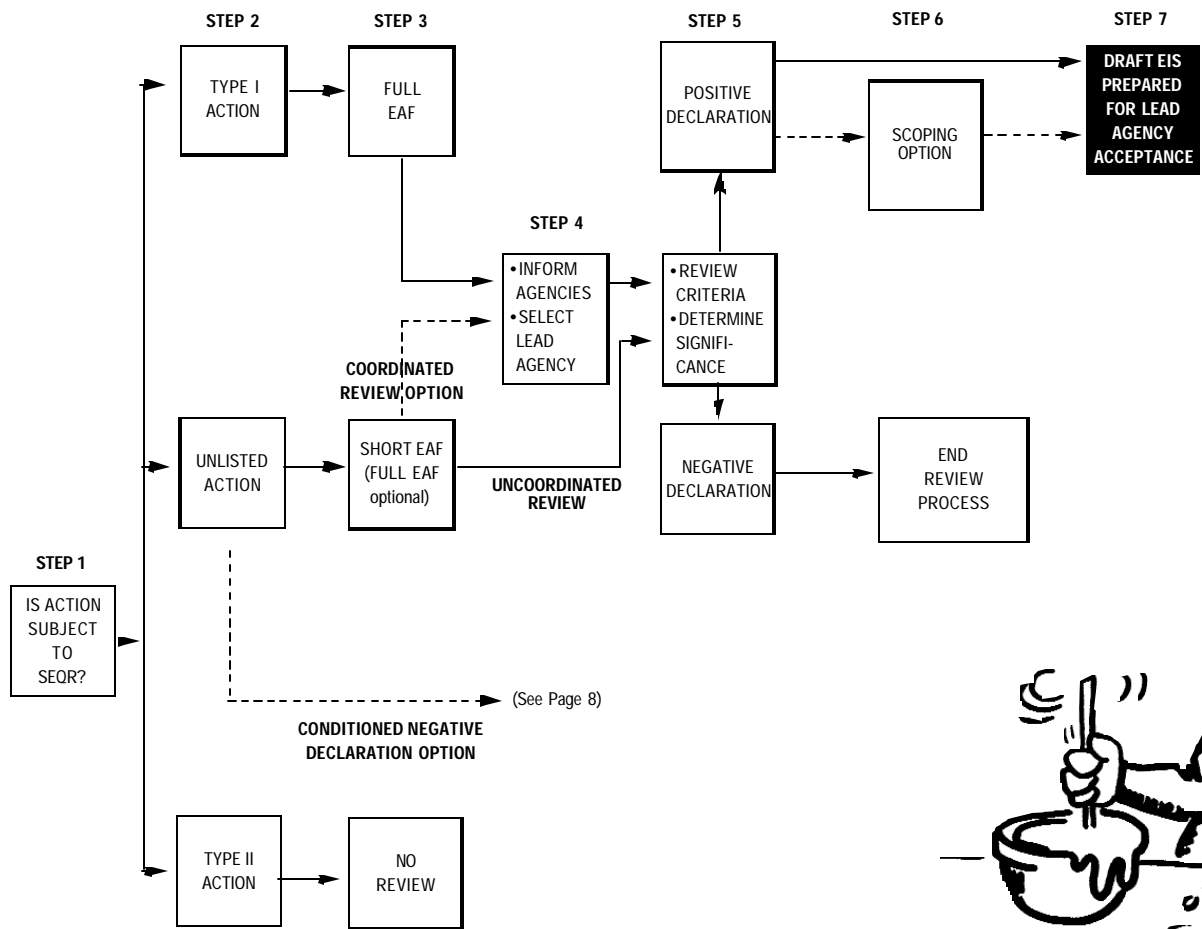

Step 7. Prepare the Draft EIS

a. Who Prepares the Draft EIS?

The applicant always has the right to prepare the draft EIS. If the applicant refuses to prepare the draft EIS, the lead agency has the option of preparing the draft EIS, having it prepared by a consultant or terminating its review of the action. If the agency decides to prepare the draft EIS or have it prepared by a consultant, it can charge the applicant a fee to recover the direct costs of preparation (See 617.13). The lead agency has the ability to charge a SEQR fee for the review of an EIS, if it does not charge a fee for its preparation.

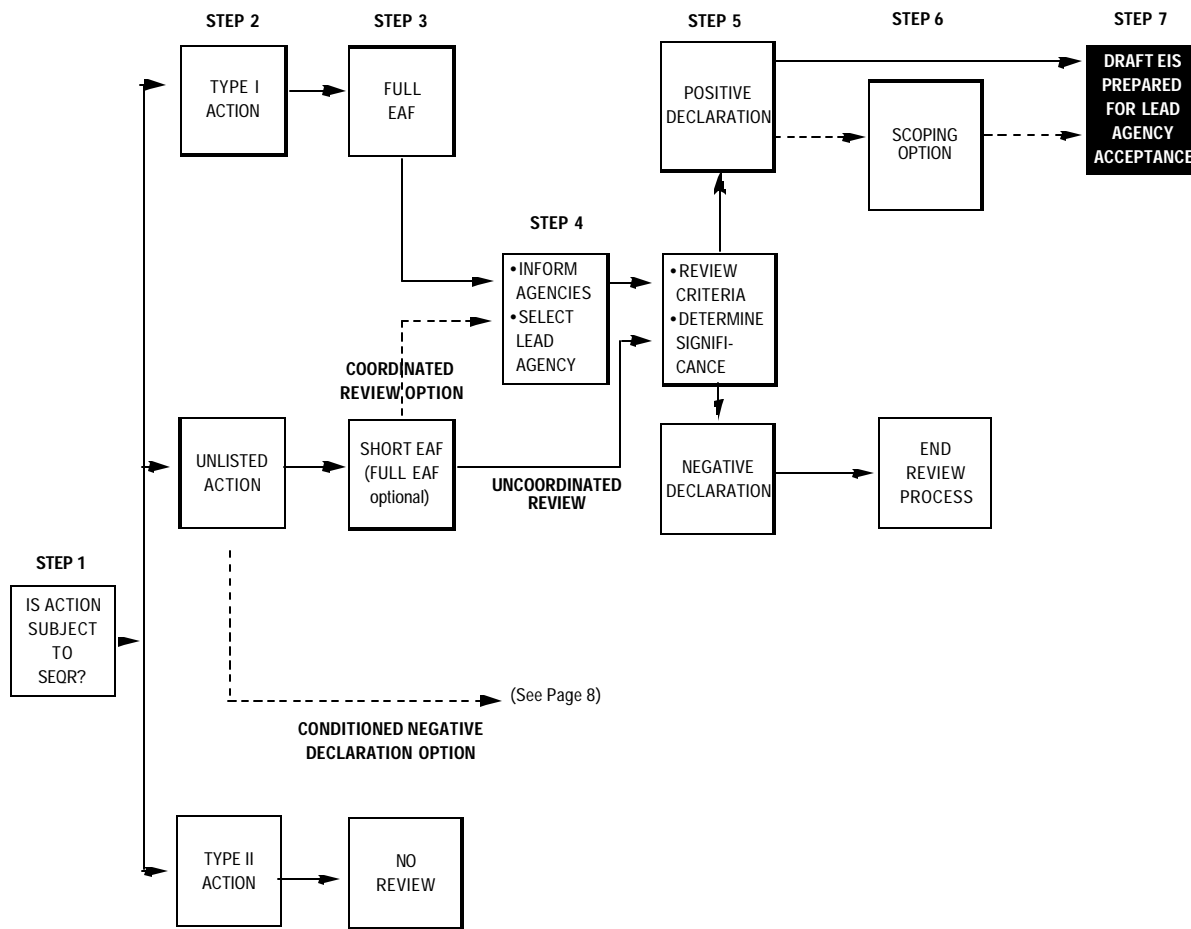

- a statement and evaluation of the potential significant adverse environmental impacts at a level of detail that reflects the severity of the impacts and the reasonable likelihood of their occurrence.
- The draft EIS should identify and discuss the following ONLY where applicable and significant:
 - reasonably related short-term and long-term impacts, cumulative impacts and other associated environmental impacts;
 - adverse environmental impacts that cannot be avoided or adequately mitigated if the proposed action is implemented;
 - any irreversible and irretrievable commitments of environmental resources that would be associated with the proposed action should it be implemented;
 - any growth-inducing aspects of the proposed action;
 - impacts of the proposed action on the use and conservation of energy;
 - impacts of the proposed action on solid waste management and its consistency with the state or locally adopted solid waste management plan;
 - impacts of public acquisitions of land or interests in land or funding for non-farm development on lands used in agricultural production and unique and irreplaceable agricultural lands within agricultural districts; and

b. Basic Components of a Draft EIS

All draft EIS's must contain a cover sheet that includes the information specified in 617.9(b)(3), a Table of Contents following the cover sheet, and an adequate and accurate summary of the statement.

The format of the draft EIS may be flexible; however, all draft EIS's must include the following elements:

- a concise description of the proposed action, its purpose, public need and benefits, including social and economic considerations;
- a concise description of the environmental setting of the areas to be affected, sufficient to understand the impacts of the proposed action and alternatives;

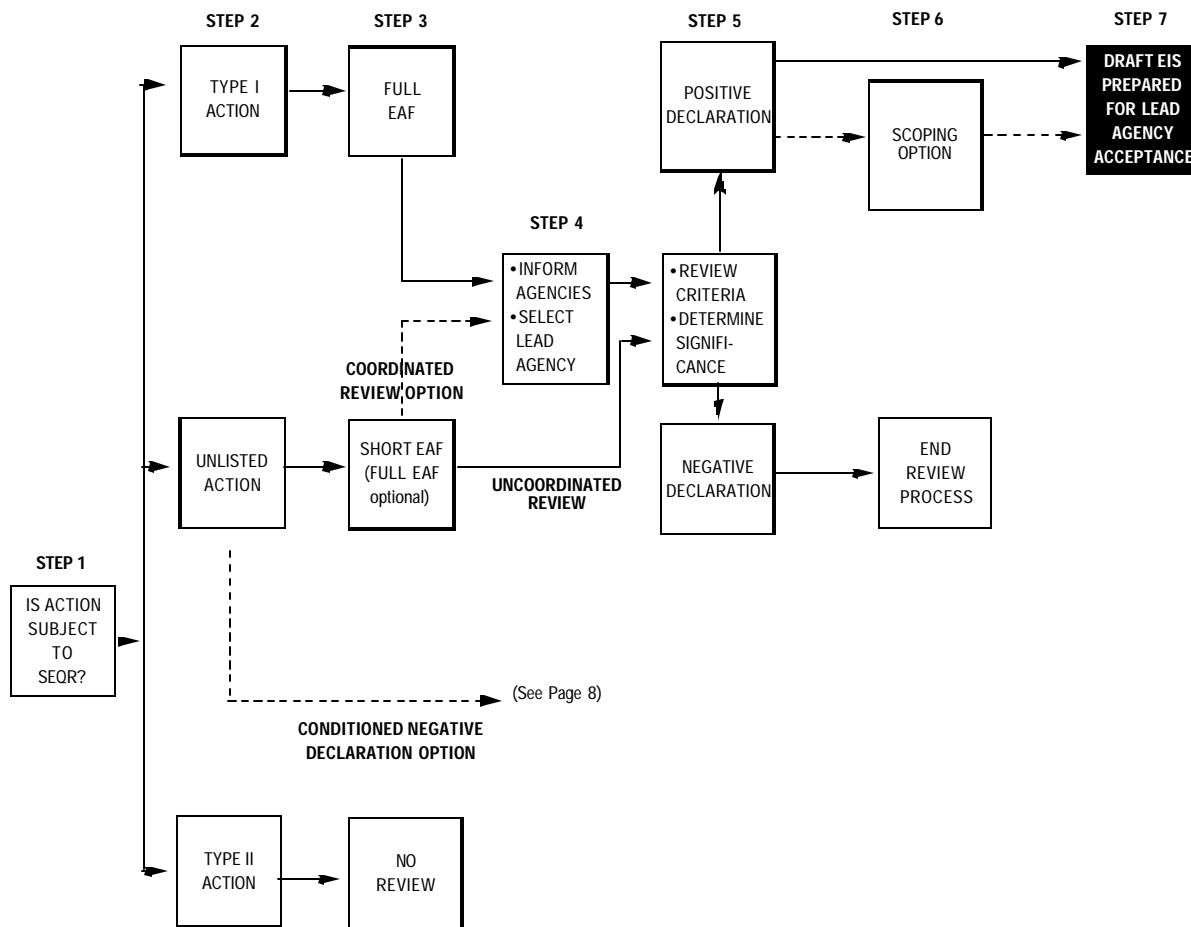

- if the proposed action is in or involves resources in Nassau or Suffolk Counties, impacts of the proposed action on, and its consistency with, the comprehensive management plan for the special groundwater protection area program;
- a description of the mitigation measures to minimize environmental impacts;
- a description and evaluation of the range of reasonable alternatives to the action that are feasible, considering the objectives and capabilities of the project sponsor. The description and evaluation of each alternative should be at a level of detail sufficient to permit a comparative assessment of the alternatives discussed. The range of alternatives must include the no-action alternative. The no-action alternative discussion should evaluate the adverse or beneficial site changes that may occur, in the absence of the proposed action. The range of alternatives may also include, as appropriate, alternative:
 - sites;
 - technology;
 - scale or magnitude;
 - design;
 - timing;
 - use; and
 - types of action.

For private project sponsors, site alternatives may be limited to parcels owned by, or under option to, a private project sponsor. See section 617.9(b)(5) for more details on EIS. Proceed to Step 8.

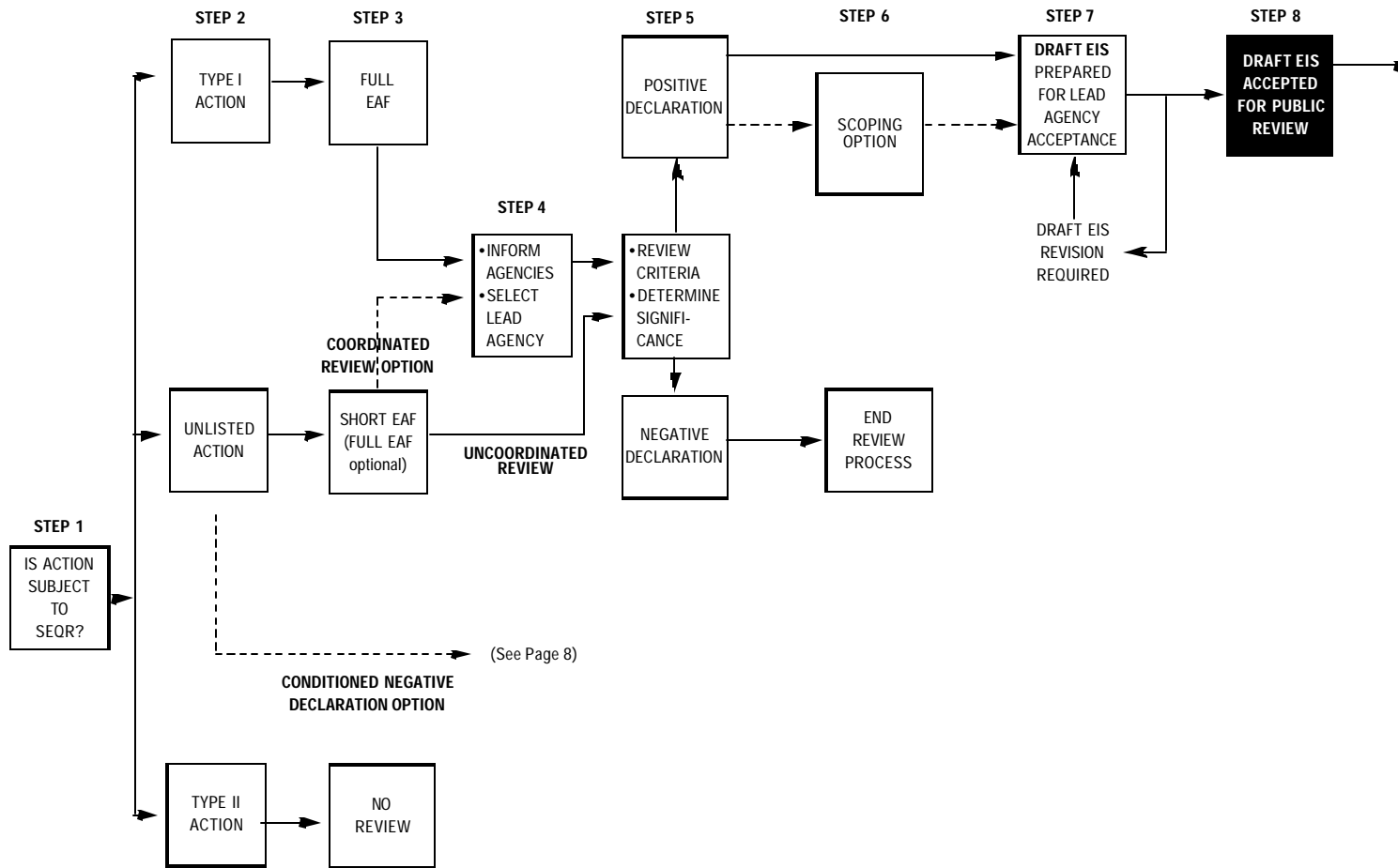

Step 8. Acceptance of the Draft EIS

Upon receipt of a submitted draft EIS, the lead agency has 45 days to determine whether the document is adequate for public review in terms of scope and content. If the lead agency decides that the draft EIS is not adequate, it returns the document to the applicant with a written identification of the deficiencies. The lead agency has 30 days to determine the adequacy of a resubmitted draft EIS. If the lead agency determines that the draft EIS is adequate, it issues a Notice of Completion of a Draft EIS. The Notice of Completion must be prepared, filed, distributed and published as prescribed in section 617.12. Proceed to Step 9.

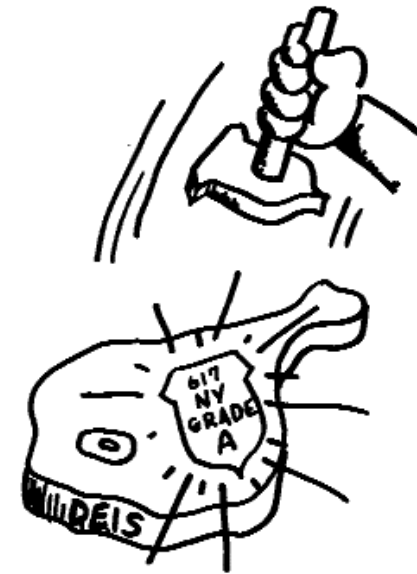

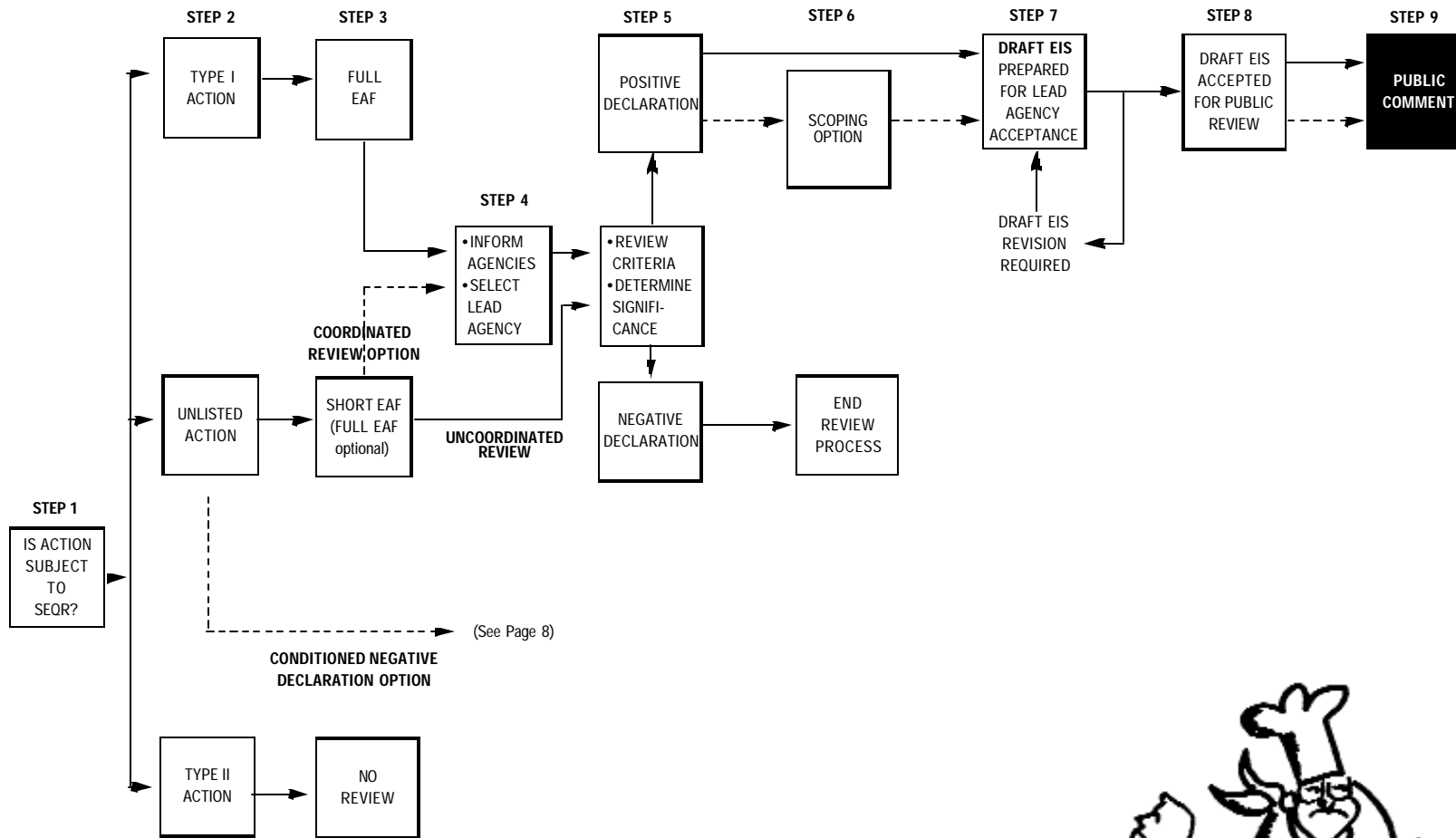

Step 9. Public Comment

The filing of the Notice of Completion of a Draft EIS starts the public comment period. That period must be a minimum of 30 days, during which all concerned parties are encouraged to offer their comments to the lead agency. The comment period may be extended if the lead agency determines that extra time is necessary. The public comment period must continue at least 10 days following the close of a public hearing, if one is held. Proceed to Step 10.

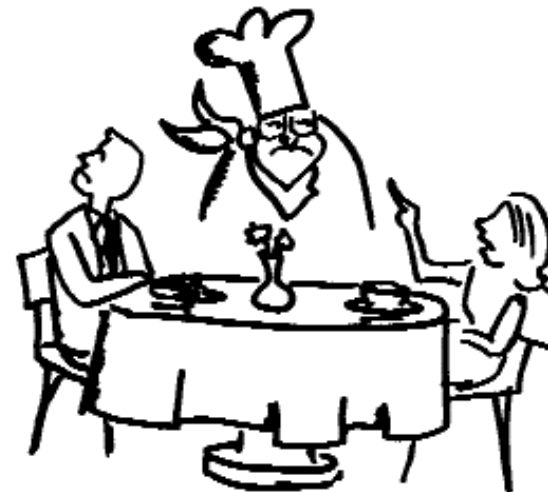

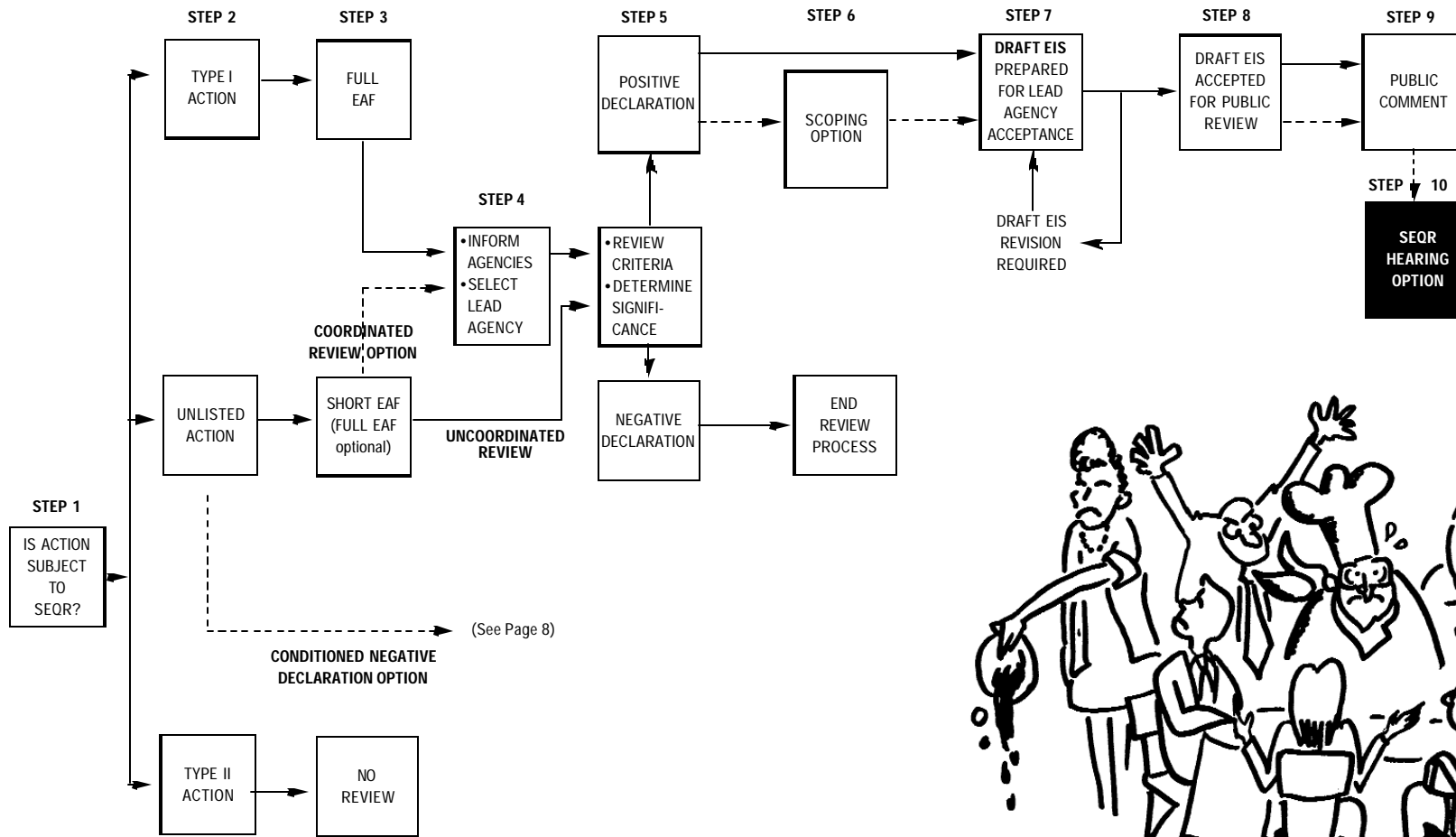

Step 10. Public Hearing

After the lead agency accepts the draft EIS, it must decide whether to hold a public hearing [see 617.9(a)(4)]. A SEQR hearing on the draft EIS is not mandatory. However, if a hearing is to be held, the lead agency must prepare and file a Notice of Public Hearing (notice). The notice may be contained in the Notice of Completion of the Draft EIS. The hearing cannot start sooner than the 15th day following the Notice of Public Hearing nor more than 60 days from the date of filing of the Notice of Completion of the Draft EIS. The notice must be prepared, filed, and distributed as prescribed in section 617.12. The notice must also be published in a newspaper of general circulation in the area of the potential impacts at least 14 days prior to the hearing date [see 617.12(c)(2)]. If a public hearing is required under an applicable local or state law, it is not necessary to hold a separate SEQR hearing. One hearing can be held to satisfy both processes. Proceed to Step 11.

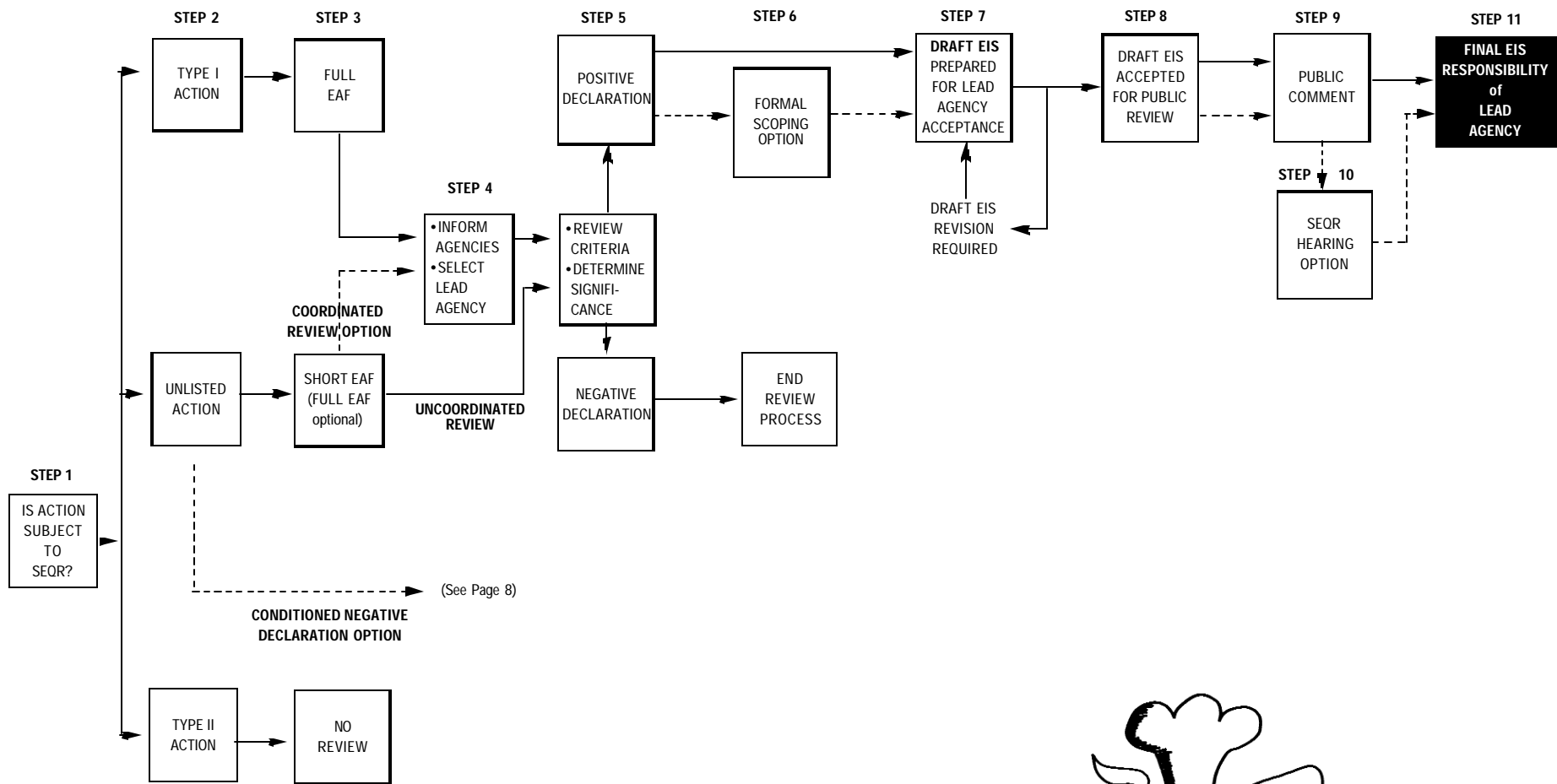

Step 11. Prepare the Final EIS

The lead agency is responsible for the adequacy and accuracy of the final EIS regardless of who prepares it. The final EIS should be prepared within 45 calendar days after the close of any hearings or within 60 days after the filing of the draft EIS, whichever occurs last. The final EIS must consist of: the draft EIS, including any necessary revisions and supplements; copies or a summary of the substantive comments received and their sources; and the lead agency's response to the comments. The Notice of Completion of the Final EIS must be prepared, filed, distributed and published as described in section 617.12. Proceed to Step 12.

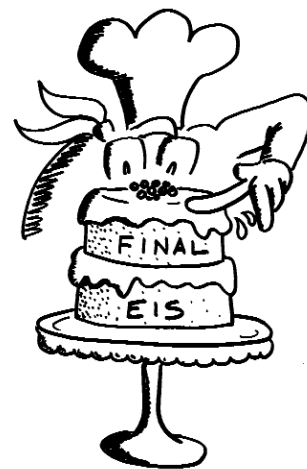

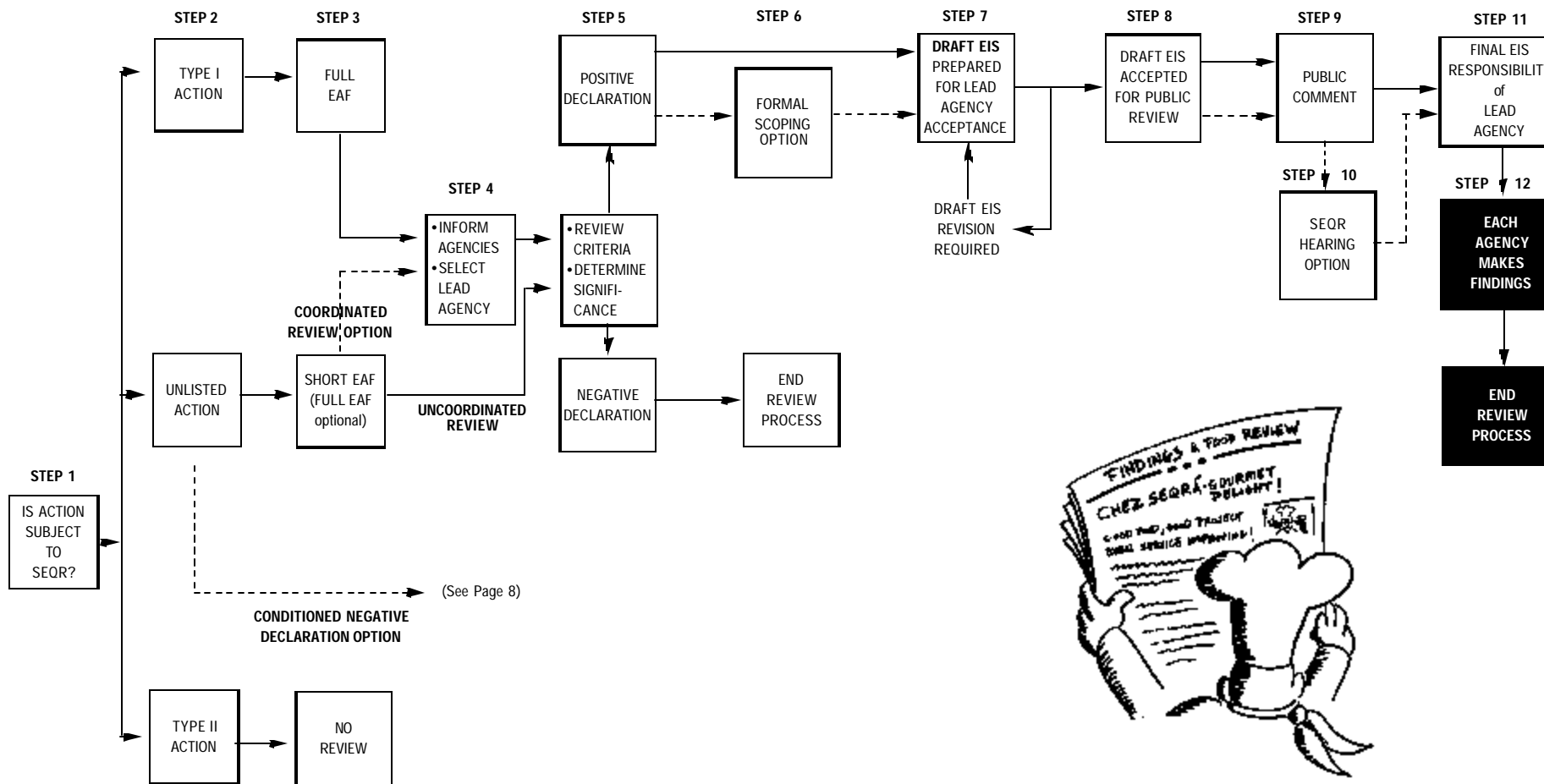

Step 12. SEQR Findings by All Involved Agencies

Part 617.11 requires that each involved agency must prepare its own written SEQR findings statement after a final EIS has been filed and before the agency makes a final decision. The findings certify that the requirements of Part 617 have been met. A positive findings statement means that the project or action is approvable after consideration of the final EIS and demonstrates that the action chosen is the one that avoids or minimizes adverse environmental impacts to the maximum extent practicable. A findings statement considers the relevant environmental impacts presented in the EIS and weighs and balances them with social, economic and other essential considerations. If the action is not approvable, a negative findings statement documenting the reasons for the denial must be prepared.

The findings can be finalized no sooner than 10 days following the filing of the Notice of Completion of the Final EIS and, if the action involves an applicant, the lead agency's findings must be made within 30 days from the filing date [617.11(b)]. Findings of each agency must be filed with all other involved agencies and the applicant at the time they are adopted. Findings and a decision may be made simultaneously.



Where can I get more information about SEQR?

Visit DEC SEQR Website at: www.dec.state.ny.us/website/dcs/seqr

The DEC SEQR Coordinator in Albany and the Regional Permit Administrators at the regional offices listed below can answer questions and provide you with the following documents which will aid you in learning SEQR procedures and requirements:

- ❖ The statewide SEQR regulations, Part 617 of 6NYCRR
- ❖ *What is SEQR?*-An introductory brochure
- ❖ *Flowchart and Timeframes* brochure
- ❖ *Applicant's Guide to SEQR* brochure
- ❖ *Local Official's Guide to SEQR* brochure
- ❖ *Citizen's Guide to SEQR* brochure

Central Office

SEQR Coordinator, DEC, 4th Floor, 625 Broadway, Albany, New York 12233-1750 E-mail: asbergst@gw.dec.state.ny.us Telephone: (518) 402-9167 Fax: (518) 402-9168



Region 1

NYSDEC, Building 40, Room 121, SUNY at Stony Brook, Stony Brook NY 11790-2356
Nassau and Suffolk Counties

Telephone: (631) 444-0359
Fax: (631) 444-0360

Region 2

NYSDEC, One Hunters Point Plaza, 47-40 21st Street, Long Island City, NY 11101-5407
New York City (Boroughs of Bronx, Brooklyn, Manhattan, Queens and Staten Island)

Telephone: (718) 482-4997
Fax: (718) 482-4975

Region 3

NYSDEC, 21 South Putt Corners Road, New Paltz, NY 12561-1696
Dutchess, Orange, Putnam, Rockland, Sullivan, Ulster and Westchester Counties

Telephone: (845) 256-3054
Fax: (845) 255-3042

Region 4

NYSDEC, 1150 North Westcott Road, Schenectady, NY 12306-2014
Albany, Columbia, Delaware, Greene, Montgomery, Otsego, Rensselaer, Schenectady and Schoharie Counties

Telephone: (518) 357-2069
Fax: (518) 357-2460

Region 5

NYSDEC, Route 86, P.O. Box 296, Ray Brook, NY 12977-0296
Clinton, Essex, Franklin, Fulton, Hamilton, Saratoga, Warren and Washington Counties

Telephone: (518) 897-1234
Fax: (518) 897-1394

Region 6

NYSDEC, State Office Building, 317 Washington Street, Watertown, NY 13601-3787
Herkimer, Jefferson, Lewis, Oneida and St. Lawrence Counties

Telephone: (315) 785-2245
Fax: (315) 785-2242

Region 7

NYSDEC, 615 Erie Boulevard West, Syracuse, NY 13204-2400
Broome, Cayuga, Chenango, Cortland, Madison, Onondaga, Oswego, Tioga and Tompkins Counties

Telephone: (315) 426-7438
Fax: (315) 426-7425

Region 8

NYSDEC, 6274 East Avon - Lima Road, Avon, NY 14414-9519
Chemung, Genesee, Livingston, Monroe, Ontario, Orleans, Schuyler, Seneca, Steuben, Wayne and Yates Counties

Telephone: (585) 226-2466
Fax: (585) 226-2830

Region 9

NYSDEC, 270 Michigan Avenue, Buffalo, NY 14203-2999
Allegany, Cattaraugus, Chataqua, Erie, Niagara and Wyoming Counties

Telephone: (716) 851-7165
Fax: (716) 851-7168

Notes